

Sink Model: D20

I.D. Size: 16" L x 16" W x 7-1/2" D

TOP VIEW

SIDE VIEW

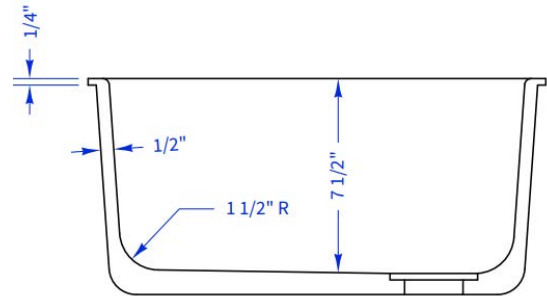
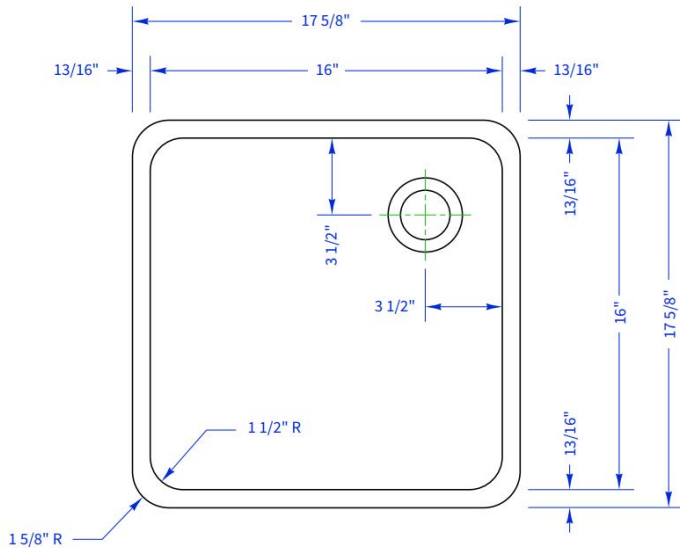

DROP-IN EPOXY SINKS:

Epoxy resin sinks as specified for Durcon Laboratory Tops, are integrally molded from modified thermosetting epoxy resins and oven cured. The bottom of the epoxy sinks are coved or sloped to the outlet drain opening, located in the corner, center or end drain.

Colors:

Industry Standard Black. Up-charge for Dark Khaki, Graphite, Gray, Tan, Lunar White & Custom Colors.

