

Pegboard: PB3024

SIZING:

Width: 30"
Height: 24"
Thickness: 1"

PEG DETAILS:

Number of Pegs: 39
Peg Sizes: 5", 6.5", 8"
Peg Color: Black or White

AVAILABLE IN:

Material: Epoxy or Phenolic
Color: Industry Standard Black. Up-charge for Gray & White

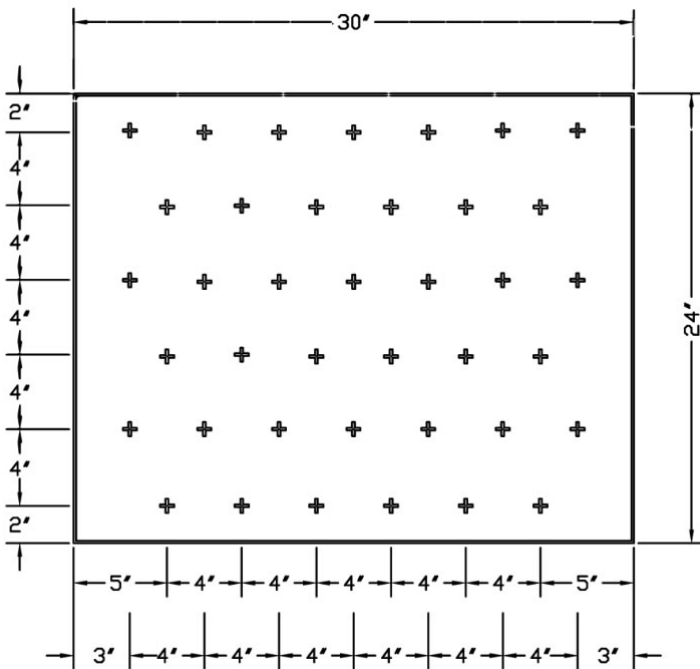

Undermount Stainless Steel Drip Trough with Hose
20 gauge material. 3/4" mounting flange with 1" deep trough with drain outlet.

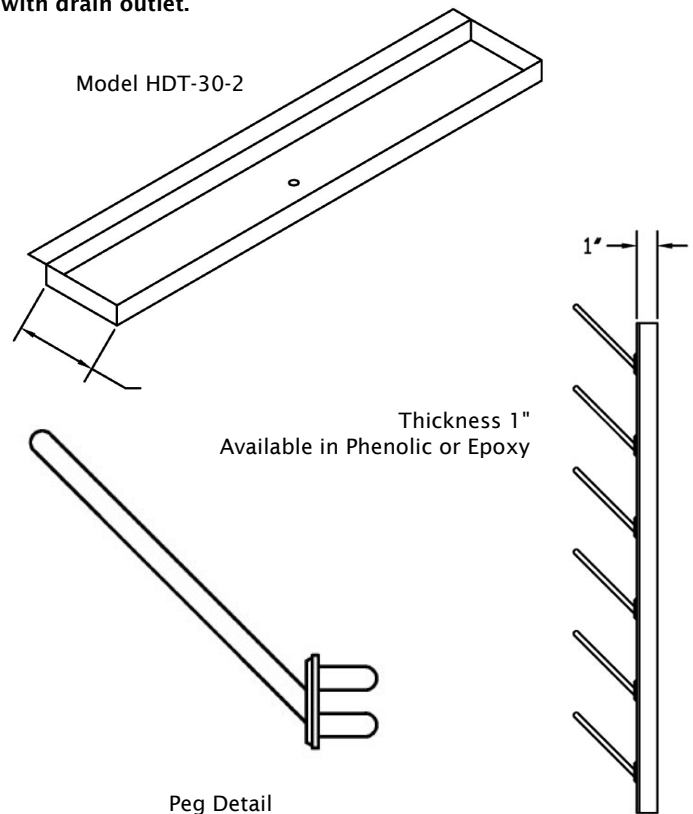

Peg Detail
 Available in White or Black Polypropylene

DETAILS:

Epoxy resin and lab grade solid phenolic pegboards can be installed on walls, uprights and columns to provide a vertical drainage/drying space for lab glassware such as test tubes, beakers or bottles. Pegboards / drying racks support glassware with specially designed "no twist" 2-prong polypropylene pegs set at a 30° angle for maximum support.

A 2" [51 mm] wide stainless steel drip tray and tubing are included with all pegboard sizes. Stainless Steel trays are available to order separately if needed.

